



Project:

Item Number:

Quantity:

SIGNATURE SERVER®: 5-WELL HOT FOOD STATION



Base pictured with stainless corner strips for laminate finish.

DESCRIPTION

Vollrath's 5-Well Hot Food Station is constructed of 18-gauge carbon steel clad with black vinyl, or optional laminate finish (all-stainless construction also available). All exposed stainless steel is type 304 polished with #4 finish or equal. Unit is mounted on heavy-duty, semi-hidden 4" (10.16 cm) diameter ball bearing swivel-type casters with non-marking treads. All casters come complete with locking plate brakes. Touch Temp® programable electronic control panel will adjust the 625 watt heating element in each individual food well. Top is one piece 18-gauge stainless steel with each well opening 19 7/8" x 11 7/8" (50.48 cm x 30.16 cm). Wells constructed of 20-gauge stainless steel and insulated by a minimum of 1 1/2" (3.81 cm) glass fiber insulation for efficient dry or moist operation. Manifold drains standard. Drain exits through side of unit. NSF4 certified.

LIGHTING (Requires breath guard) (Bulbs not included)

Note: Lighting options for breath protector components require that 120/208V AC or 120/240V AC be selected.

Incandescent/Infrared (Bulbs not included)

Attractively display and merchandise food or provide heat from above.

- 36433 Incandescent/Infared, 74" (187.96 cm) Length

Fluorescent (Bulbs not included)

Illuminates food attractively while providing more room under breath guard. Includes shield for light tube.

- 36423 Fluorescent, 74" (187.96 cm) Length

Heat Strip (Bulbs not included)

Order alone or with incandescent lighting. Not available for use with cafeteria double-deck display shelf. Heat strips with lights not available for cafeteria single-deck breath guard.

- 36403 Heat Strip Only, 74" (187.96 cm) Length
- 36413 Heat Strip with Lights, 74" (187.96 cm) Length

Agency Certifications



MODELS:

- 36250 27" (68.58 cm) Height 5-Well Station
- 36150 30" (76.20 cm) Height 5-Well Station
- 37050 34" (86.36 cm) Height 5-Well Station

Voltage Specifications

- 120/240V, 1 PH 240V, 1 PH 208V, 1PH 120/208V, 1 PH

Optional Finishes

- 36682 Matte Finish Brand _____ Color _____
- 36689 Woodgrain Brand _____ Color _____
- 36695 All Stainless

Optional solid surface and laminate tops available. Contact the factory.

BREATH GUARD

Cafeteria Breath Guard

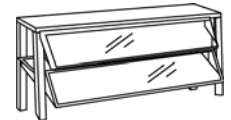
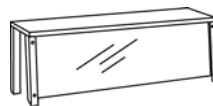

Single Shelf

Twelve inch wide (30.48 cm) shelf is constructed of 18-gauge stainless steel and front panel is heavy-duty 1/4" (.63 cm) clear acrylic. Serving shelf and acrylic panel attach to 1" (2.54 cm) square tubular stainless steel uprights.

Double Shelf

Top shelf is 18-gauge stainless steel and 12" (30.48 cm) wide. Intermediate shelf is 1/4" (.63 cm) acrylic. Shelves mounted to 1" (2.54 cm) square tubular stainless steel uprights. Breath guards are 1/4" (.63 cm) clear acrylic and are adjustable/pivot to provide access to serving areas.

- 37313 Single Shelf, 74" (187.96 cm) Length
- 37323 Double Shelf, 74" (187.96 cm) Length

Access Breath Guard

Top shelf constructed of 18-gauge carbon steel clad with black vinyl, optional laminate or stainless steel. Side and end panels constructed of 1/4" (.63 cm) clear acrylic. Uprights built of 18-gauge stainless steel. Provides 12" (30.48 cm) height clearance/serving opening when in use. Adjustable Access Breath Guard provides serving opening range of 9"-15" (22.8-38.1 cm) in one inch (2.54 cm) increments. NSF certified.

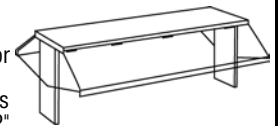

- 36373 Adjustable Access Breath Guard, 74" (187.96 cm) Length
- 36371 Non-Adjustable Access Breath Guard, 74" (187.96 cm) Length

Buffet Breath Guard

Constructed of 18-gauge 1" (2.54 cm) square tubular stainless steel uprights. Panels made of 1/4" (.63 cm) clear acrylic. Side panels provide 12" (30.48 cm) clearance/serving opening when attached to Vollrath Signature Server® Base.



- 36303 Buffet Breath Guard 74", (187.96 cm) Length

Optional powdercoat or brass breath guards available. Contact the factory.

Approvals

Date:

--	--



www.vollrathco.com

The Vollrath Company, L.L.C.
1236 North 18th Street
Sheboygan, WI 53082-0611
U.S.A.
Main Tel: 800.624.2051
Service Tel: 800.628.0832
FAX: 800.752.5620

Vollrath of Canada, Ltd.
6320 Danville Road, Unit 1
Mississauga, Ontario L5T 2L7
Canada
Tel: 905.565.1167
Tel: 800.695.8560
FAX: 905.565.1168

SIGNATURE SERVER®: 5-WELL HOT FOOD STATION**ACCESSORIES AND ADD ONS****Tray Slide with Mounting Kit**

Constructed of 18-gauge stainless steel with 4 ribs. Bracket provides 4¾" (12.07 cm) tray slide height adjustment. 11½" (29.21 cm) wide with 1" (2.54 cm) turned down flange. Locking brackets on each end to join stations together. Adds 5½" (13.97 cm) to width of unit in folded position.

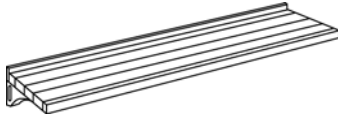

- 37524 Tray Slide with Mounting Kit, 74" (187.96 cm) Length

Stationary Legs

Constructed of plated metal. Threaded insert with height adjustment of 1" (2.54 cm).



Adjustable
from 4" to 5"
(10.16 cm to
12.7 cm)

- 36921 Stationary Legs

End Shelf

Constructed of 18-gauge stainless steel with fold-down style mounting bracket. Attaches to 46" (117 cm), 60" (152.4 cm) and 74" (187.96 cm) Signature Servers. Adds 4½" (11.43 cm) to length of unit in folded position. Must be factory installed.

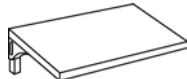

- 37570 End Shelf, 18" x 28" (45.72 cm x 71.12 cm)

Plate Rest or Stainless Cutting Board with Mounting Kit

Made of 18-gauge stainless steel with fold-down style mounting bracket. 7" (17.78 cm) wide with 1" (2.54 cm) turned down flange. Locking brackets on each end to join stations together. Adds 4½" (11.43 cm) to width of unit in folded position.

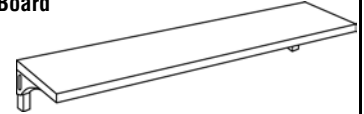

- 37514 Plate Rest with Mounting Kit, 74" (187.96 cm) Length

Storage Module (34" (86.36 cm) Height Units Only)

Constructed of 18-gauge stainless steel and formed to allow flange to fit over exterior surface of server base. Doors are constructed of 18-gauge carbon steel clad with black vinyl, laminated finish or stainless steel.

Storage Module with Doors

36938 (50" x 16½" x 24½")
(127 cm x 41.91 cm x 62.23 cm)

Storage Module without Doors

36939 (50" x 16½" x 24½")
(127 cm x 41.91 cm x 62.23 cm)

Cutting Board

Wood cutting board made of 1⅛" (2.86 cm) thick sectional kiln dried maple. Poly cutting board is 1" (2.54 cm) thick. Both NSF certified. Boards have chrome plate fold-down style mounting brackets. Removable without tools. Adds 4½" (11.43 cm) to width of unit in folded position.



- 37553 Wood, 74" (187.96 cm) 37563 Poly, 74" (187.96 cm)

DIMENSIONS

- Dimensions in inches (cm).

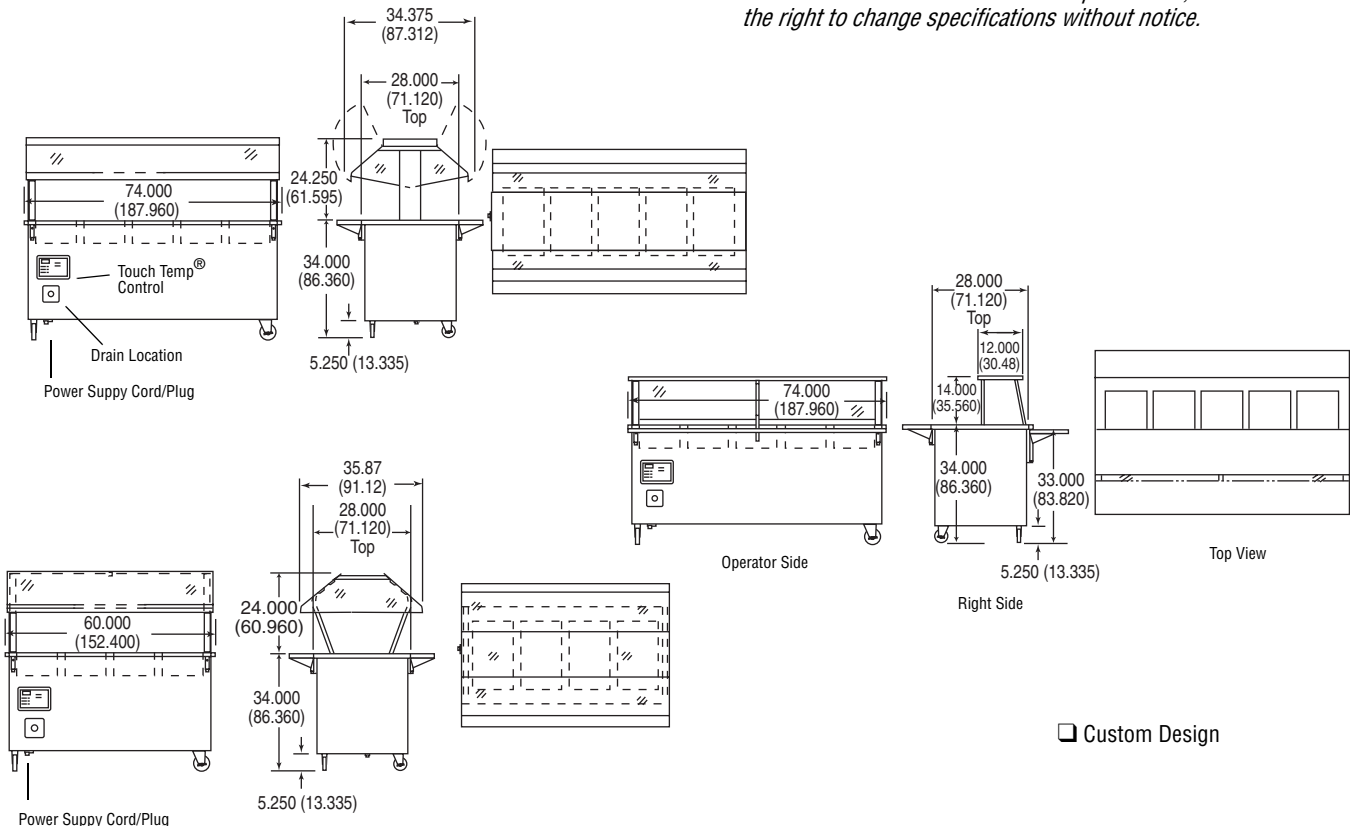

www.vollrathco.com

The Vollrath Company, L.L.C.
1236 North 18th Street
Sheboygan, WI 53082-0611
U.S.A.
Main Tel: 800.624.2051
Service Tel: 800.628.0832
FAX: 800.752.5620

Vollrath of Canada, Ltd.
6320 Danville Road, Unit 1
Mississauga, Ontario L5T 2L7
Canada
Tel: 905.565.1167
Tel: 800.695.8560
FAX: 905.565.1168

©2004 The Vollrath Company L.L.C Form Number L35358 Rev. 3/04

Printed in USA