



Project:

Item Number:

Quantity:

SIGNATURE SERVER®: 3-WELL HOT FOOD STATION



Base pictured with stainless corner strips for laminate finish.

DESCRIPTION

Vollrath's 3-Well Hot Food Station is constructed of 18-gauge carbon steel clad with black vinyl, or optional laminate finish (all-stainless construction also available). All exposed stainless steel is type 304 polished with #4 finish or equal. Unit is mounted on heavy-duty, semi-hidden 4" (10.16 cm) diameter ball bearing swivel-type casters with non-marking treads. All casters come complete with locking plate brakes. Touch Temp® programable electronic control panel will adjust the 625 watt heating element in each individual food well. Top is one piece 18-gauge stainless steel with each well opening 19⁷/₈" x 11⁷/₈" (50.48 cm x 30.16 cm). Wells constructed of 20-gauge stainless steel and insulated by a minimum of 1¹/₂" (3.81 cm) glass fiber insulation for efficient dry or moist operation. Manifold drains standard. Drain exits through side of unit. NSF4 certified.

LIGHTING (Requires breath guard) (Bulbs not included)

Note: Lighting options for breath protector components require that 120V AC, 120/208V AC, or 120/240V AC be selected.

Incandescent/Infrared (Bulbs not included)

Attractively display and merchandise food or provide heat from above.

- 36431 Incandescent/Infared, 46" (117 cm) Length

Fluorescent (Bulbs not included)

Illuminates food attractively while providing more room under breath guard. Includes shield for light tube.

- 36421 Fluorescent, 46" (117 cm) Length

Heat Strip (Bulbs not included)

Order alone or with incandescent lighting. Not available for use with cafeteria double-deck display shelf. Heat strips with lights not available for cafeteria single-deck breath guard.

- 36401 Heat Strip Only, 46" (117 cm) Length
- 36411 Heat Strip with Lights, 46" (117 cm) Length

Agency Certifications



MODELS:

- 36230 27" (68.58 cm) Height 3-Well Station
- 36130 30" (76.20 cm) Height 3-Well Station
- 37030 34" (86.36 cm) Height 3-Well Station

Voltage Specifications

- 240V, 1PH
- 120/240V, 1PH
- 120/208V, 1PH
- 208V, 1PH
- 120V, 1PH

Optional Finishes

- 36680 Matte Finish Brand _____ Color _____
- 36687 Woodgrain Brand _____ Color _____
- 36693 All Stainless

Optional solid surface and laminate tops available. Contact the factory.

BREATH GUARD

Cafeteria Breath Guard

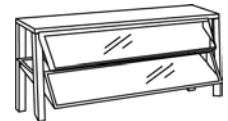

Single Shelf

Twelve inch (30.48 cm) wide shelf is constructed of 18-gauge stainless steel and front panel is heavy-duty 1/4" (.63 cm) clear acrylic. Serving shelf and acrylic panel attach to 1" (2.54 cm) square tubular stainless steel uprights.

Double Shelf

Top shelf is 18-gauge stainless steel and 12" (30.48 cm) wide. Intermediate shelf is 1/4" (.63 cm) acrylic. Shelves mounted to 1" (2.54 cm) square tubular stainless steel uprights. Breath guards are 1/4" (.63 cm) clear acrylic and are adjustable/pivot to provide access to serving areas.

- 37311 Single Shelf, 46" (117 cm) Length
- 37321 Double Shelf, 46" (117 cm) Length

Access Breath Guard

Top shelf constructed of 18-gauge carbon steel clad with black vinyl, optional laminate or stainless steel. Side and end panels constructed of 1/4" (.63 cm) clear acrylic. Uprights built of 18-gauge stainless steel. Provides 12" (30.48 cm) height clearance/serving opening when in use. Adjustable Access Breath Guard provides serving opening range of 9"-15" (22.8-38.1 cm) in one inch (2.54 cm) increments. NSF certified.

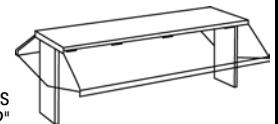

- 36343 Adjustable Access Breath Guard, 46" (117 cm) Length
- 36341 Non-Adjustable Access Breath Guard, 46" (117 cm) Length

Buffet Breath Guard

Constructed of 18-gauge 1" (2.54 cm) square tubular stainless steel uprights. Panels made of 1/4" (.63 cm) clear acrylic. Side panels provide 12" (30.48 cm) height clearance/serving opening when attached to Vollrath Signature Server® Base.



- 36301 Buffet Breath Guard, 46" (117 cm) Length

Optional powdercoat or brass breath guards available. Contact the factory.

Approvals

Date:

| | |
|--|--|
| | |
|--|--|



www.vollrathco.com

The Vollrath Company, L.L.C.
1236 North 18th Street
Sheboygan, WI 53082-0611
U.S.A.
Main Tel: 800.624.2051
Service Tel: 800.628.0832
FAX: 800.752.5620

Vollrath of Canada, Ltd.
6320 Danville Road, Unit 1
Mississauga, Ontario L5T 2L7
Canada
Tel: 905.565.1167
Tel: 800.695.8560
FAX: 905.565.118

SIGNATURE SERVER®: 3-WELL HOT FOOD STATION

ACCESSORIES AND ADD ONS

Tray Slide with Mounting Kit

Constructed of 18-gauge stainless steel with 4 ribs. Bracket provides 4¾" (12.07 cm) tray slide height adjustment. 11½" (29.21 cm) wide with 1" (2.54 cm) turned down flange. Locking brackets on each end to join stations together. Adds 5½" (13.97 cm) to width of unit in folded position.

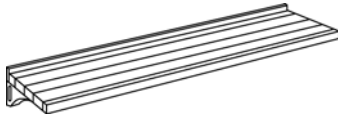

- 37522 Tray Slide with Mounting Kit, 46" (117 cm) Length

Stationary Legs

Constructed of plated metal. Threaded insert with height adjustment of 1" (2.54 cm).

- 36921 Stationary Legs



Adjustable
from 4" to 5"
(10.16 cm to
12.7 cm)

End Shelf

Constructed of 18-gauge stainless steel with fold-down style mounting bracket. Attaches to 46" (117 cm), 60" (152.4 cm) and 74" (187.96 cm) Signature Servers. Adds 4½" (11.43 cm) to length of unit in folded position. Must be factory installed.

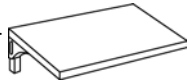

- 37570 End Shelf, 18" x 28" (45.72 cm x 71.12 cm)

Plate Rest or Stainless Cutting Board with Mounting Kit

Made of 18-gauge stainless steel with fold-down style mounting bracket. 7" (17.78 cm) wide with 1" (2.54 cm) turned down flange. Locking brackets on each end to join stations together. Adds 4½" (11.43 cm) to width of unit in folded position.

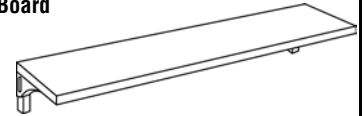

- 37512 Plate Rest with Mounting Kit, 46" (117 cm) Length

Storage Module (34" (86.36 cm) Height Units Only)

Constructed of 18-gauge stainless steel and formed to allow flange to fit over exterior surface of server base. Doors are constructed of 18-gauge carbon steel clad with black vinyl, laminated finish or stainless steel.

Storage Module with Doors

- 36930 (24" x 16½" x 24½")

Storage Module without Doors

- 36931 (24" x 16½" x 24½")
(60.96 cm x 41.91 cm x 62.23 cm) (60.96 cm x 41.91 cm x 62.23 cm)

Cutting Board

Wood cutting board made of 1½" (2.86 cm) thick sectional kiln dried maple. Poly cutting board is 1" (2.54 cm) thick. Both NSF certified. Boards have chrome plate fold-down style mounting brackets. Removable without tools. Adds 4½" (11.43 cm) to width of unit in folded position.

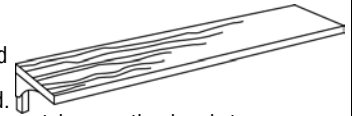

- 37551 - Wood 46" (117 cm) 37561 Poly 46" (117 cm)

Note: In the interest of continued improvement, we reserve the right to change specifications without notice.

DIMENSIONS

- Dimensions in inches (cm).

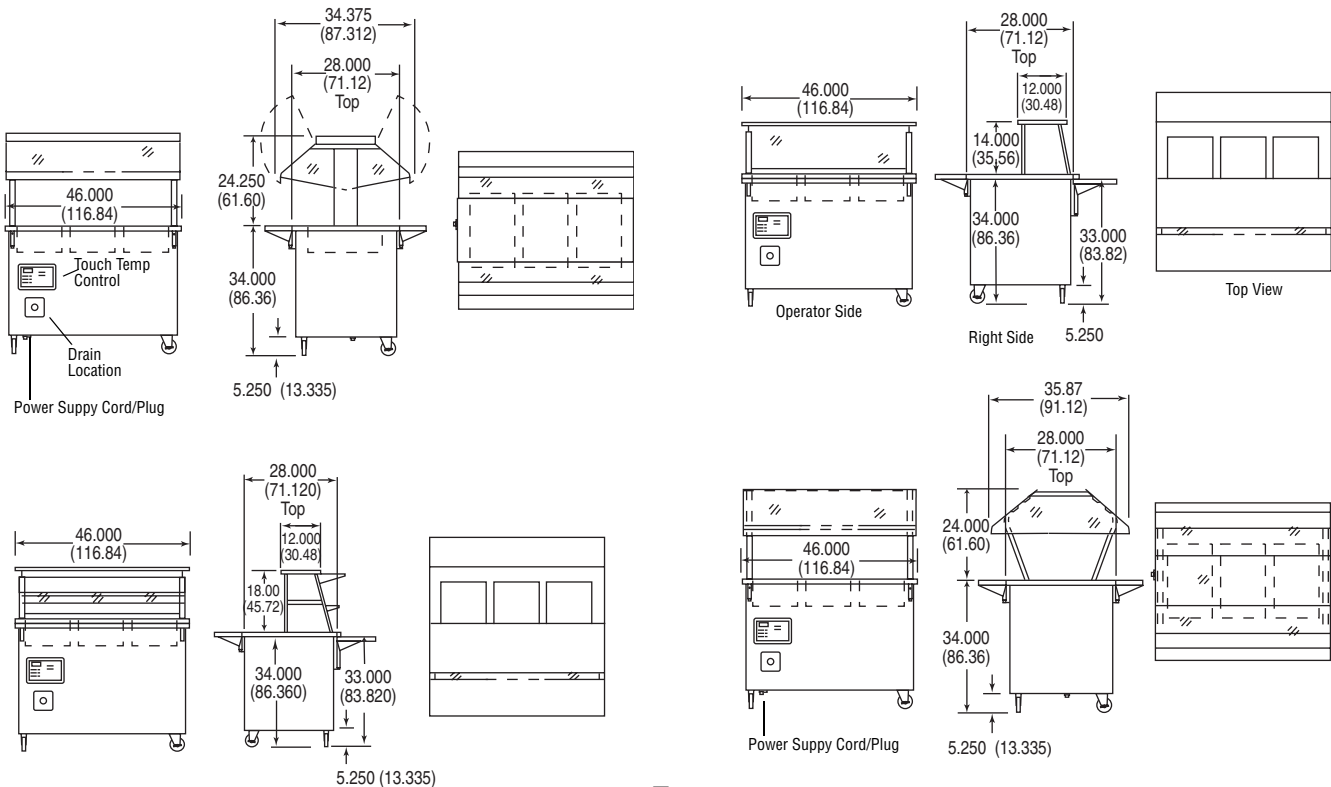

- Custom Design



www.vollrathco.com

The Vollrath Company, L.L.C.
1236 North 18th Street
Sheboygan, WI 53082-0611
U.S.A.
Main Tel: 800.624.2051
Service Tel: 800.628.0832
FAX: 800.752.5620

Vollrath of Canada, Ltd.
6320 Danville Road, Unit 1
Mississauga, Ontario L5T 2L7
Canada
Tel: 905.565.1167
Tel: 800.695.8560
FAX: 905.565.1168

©2004 The Vollrath Company L.L.C Form Number L35356 Rev. 3/04

Printed in USA