



# THE HIGH h BATCH 2™



### PERFORMANCE

- Heat transfer rates (h) are 3X-4X typical convection oven
- Heat transfer rates (h) are 2X typical conveyor oven
- The High h Batch 2 offers high quality, full baking capabilities up to 5X faster than traditional cooking equipment, achieving conveyor-type results in a compact size

### VENTILATION

- UL (KNLZ) listed for ventless operation.†
- EPA 202 test (8 hr):
  - Product / Results
    - Fries, Chicken Breasts, Chicken Wings, and Ground Beef Patties / 0.10 mg/m<sup>3</sup>
    - Pepperoni Pizzas / 0.40 mg/m<sup>3</sup>
  - Ventless Requirement: <5.00 mg/m<sup>3</sup>
- Internal catalytic filtration to limit smoke, grease, and odor emissions.

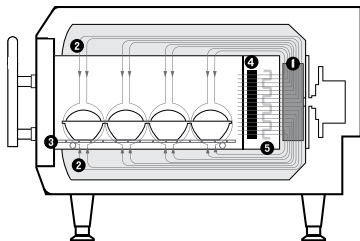

1. Blower Motor
2. Impinged Air
3. Oscillating Rack
4. Catalytic Converter
5. Impingement Heater

Project \_\_\_\_\_

Item No. \_\_\_\_\_

Quantity \_\_\_\_\_

### EXTERIOR CONSTRUCTION

- Stainless steel front, top, back, and powder-coated sides
- 4" (102 mm) matte black legs
- Ergonomic, cool to touch powder-coated door handle

### INTERIOR CONSTRUCTION

- 304 stainless steel interior
- Watertight construction
- Interchangeable jetplates for customized cooking results

### STANDARD FEATURES

- Integral recirculating catalytic converter for UL® (KNLZ) listed ventless operation
- Variable-speed High h recirculating air impingement system
- Oscillating rack for high heat transfer without spotting
- Half-sheet pan/16-inch pizza capacity
- Smart Voltage Sensor Technology\* (N.A. only)
- Stackable design (requires stacking kit)
- Smart menu system capable of storing up to 72 recipes
- Built-in self diagnostics for monitoring oven components and performance
- Includes plug and cord (6 ft. nominal)
- Smart card compatible
- Warranty – 1 year parts and labor

### COMES WITH STANDARD ACCESSORIES

- 1 Aluminum Paddle (NGC-1478)
- 1 Bottle Oven Cleaner (103180)
- 1 Bottle Oven Guard (103181)
- 2 Trigger Sprayers (103182)
- 1 14x16 PTFE Screen (100018)



This product conforms to the ventilation recommendations set forth by NFPA96 using EPA202 test method.

\* Smart Voltage Sensor Technology does not compensate for lack of or over voltage situations. It is the responsibility of the owner to supply voltage to the unit according to the specifications on the back of this sheet.



† Ventless certification is for all food items except for foods classified as "fatty raw proteins." Such foods include bone-in, skin-on chicken, raw hamburger meat, raw bacon, raw sausage, steaks, etc. If cooking these types of foods, consult local HVAC codes and authorities to ensure compliance with ventilation requirements.

Ultimate ventless allowance is dependent upon AHJ approval, as some jurisdictions may not recognize UL certification or application. If you have questions regarding ventless certifications or local codes please email [ventless.help@turbochef.com](mailto:ventless.help@turbochef.com)

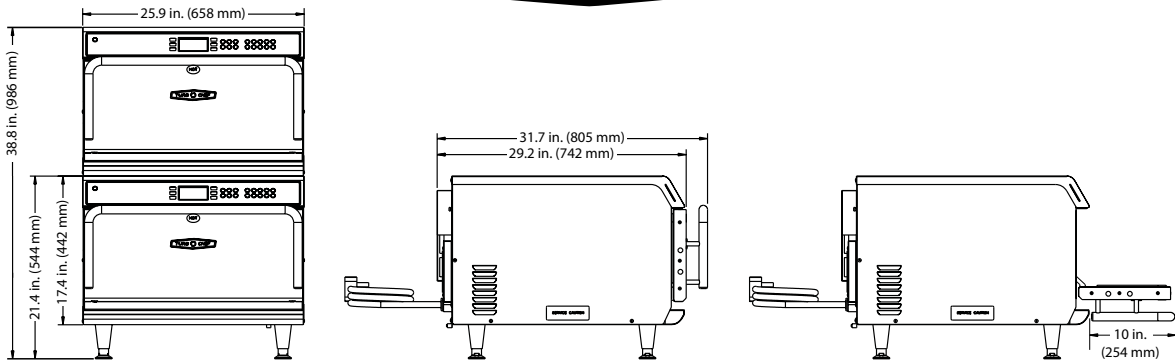
TurboChef reserves the right to make substitutions of components or change specifications without prior notice.

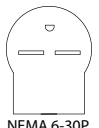
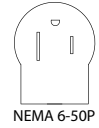

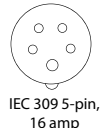
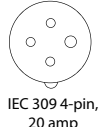
DIMENSIONS		
Single Units		
Height	21.4"	544 mm
Width	25.9"	658 mm
Depth	29.2"	742 mm
with handle	31.7"	805 mm
Weight	157 lb.	71 kg
Stacked Units (Stacking Kit Required)		
Height	38.8"	986 mm
top unit with legs	42.8"	1087 mm
Width	25.9"	658 mm
Depth	29.2"	742 mm
with handle	31.7"	805 mm
Weight	314 lb.	142 kg
Cook Chamber		
Height	8"	203 mm
Width	18.75"	476 mm
Depth	16.75"	425 mm
Volume	1.45 cu. ft.	41.1 liters
Wall Clearance (Oven not intended for built-in installation)		
Top	2"	51 mm
Sides	2"	51 mm
ELECTRICAL SPECIFICATIONS		
UNITED STATES		
HHB2 (HHB-8603-1)		
Phase	1 Phase	 NEMA 6-30P
Voltage	208/240 VAC	
Frequency	50/60 Hz	
Current / Max Circuit Requirement	24 / 30 amp	
Cord	10 gauge, 3 wire, 5 ft., SOOW	
Max Input	5000 watts	
CANADA		
HHB2C (HHB-8603-1C)		
Phase	1 Phase	 NEMA 6-50P
Voltage	208/240 VAC	
Frequency	50/60 Hz	
Current / Max Circuit Requirement	24 / 50 amp	
Cord	10 gauge, 3 wire, 5 ft., SOOW	
Max Input	5000 watts	

LATIN AMERICA		
HHB2LA (HHB-8603-1K-2073)		
Phase	1 Phase	 NEMA 6-30P
Voltage	230 VAC	
Frequency	50/60 Hz	
Current / Max Circuit Requirement	24 / 32 amp	
Cord	10 gauge, 3 wire, 5 ft., SOOW	
Max Input	5000 watts	
EUROPE/ASIA-PACIFIC		
HHB2EW (HHB-8603-1W)		
Phase	3 Phase	 IEC 309 5-pin, 16 amp
Voltage	400 VAC	
Frequency	50/60 Hz	
Current / Max Circuit Requirement	10 / 16 amp	
Cord	HO7RN-F, 5 wire	
Max Input	5000 watts	
HHB2ED (HHB-8603-1D)		
Phase	3 Phase	 IEC 309 4-pin, 20 amp
Voltage	230 VAC	
Frequency	50/60 Hz	
Current / Max Circuit Requirement	14 / 20 amp	
Cord	HO7RN-F, 4 wire	
Max Input	5000 watts	
HHB2UK (HHB-8603-1K)		
Phase	1 Phase	 IEC 309 3-pin, 32 amp
Voltage	230 VAC	
Frequency	50/60 Hz	
Current / Max Circuit Requirement	24 / 32 amp	
Cord	HO7RN-F, 3 wire	
Max Input	5000 watts	
SHIPPING INFORMATION		
U.S.: All ovens shipped within the U.S. are packaged in a double-wall corrugated box banded to a wooden skid.		
International: All International ovens shipped via Air or Less than Container Loads are packaged in wooden crates.		
Box size: 37" x 32" x 28" (940 mm x 813 mm x 711 mm)		
Crate size: 40" x 36" x 35" (1016 mm x 914 mm x 889 mm)		
Item class: 85 NMFC #26770 HS code 8419.81		
Approximate boxed weight: 210 lb. (95 kg)		
Approximate crated weight: 285 lb. (129 kg)		
Minimum entry clearance required for box: 28.5" (724 mm)		
Minimum entry clearance required for crate: 35.5" (902 mm)		

TurboChef Global Operations  
 2801 Trade Center Drive / Carrollton, Texas 75007 USA  
 US: 800.90TURBO (800.908.8726) / International: +1 214.379.6000  
 Fax: +1 214.379.6073 / turbochef.com

TurboChef reserves the right to make substitutions of components or change specifications without prior notice.